



IMPROVE ACCURACY AND REDUCE COSTS

Specim FX10 camera series is designed for industrial and laboratory use. Specim FX10 cameras work in a line-scan mode in the visible and near-infrared (VNIR) area; Specim FX10 in the 400-1000 nm region, and the color optimized Specim FX10c camera in the 400-780 nm region.

Specim FX10 cameras are best suited for:

- Vegetation & agriculture
- Phenotyping
- Color & density in printing
- Display & light source inspection
- Food quality

FEATURES

- Spectral range of 400-1000 / 400-780 nm
- High spatial resolution of 1024 pixels
- High image speed of 330 FPS (full range)
- Free wavelength selection from 224 bands within the camera coverage
- Built-in image correction
- Unified spectral calibration between units
- GigE or CameraLink standard interfaces
- Easy mounting to industrial environment

SPECTRAL RESPONSE

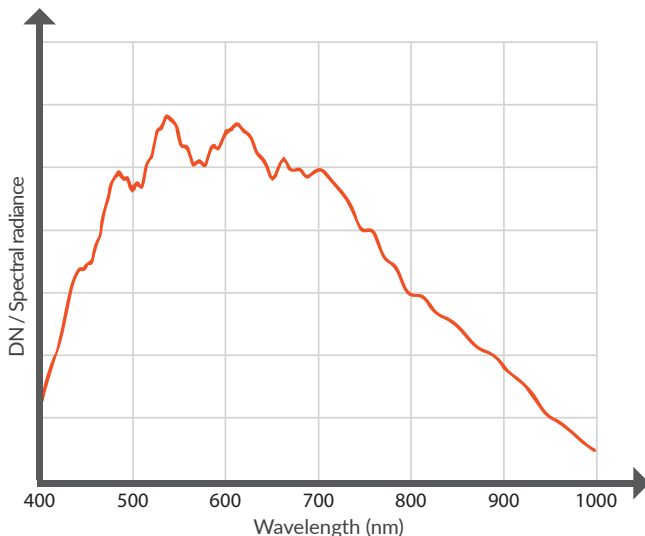

DIMENSIONS

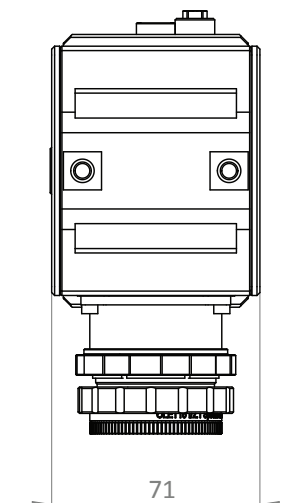
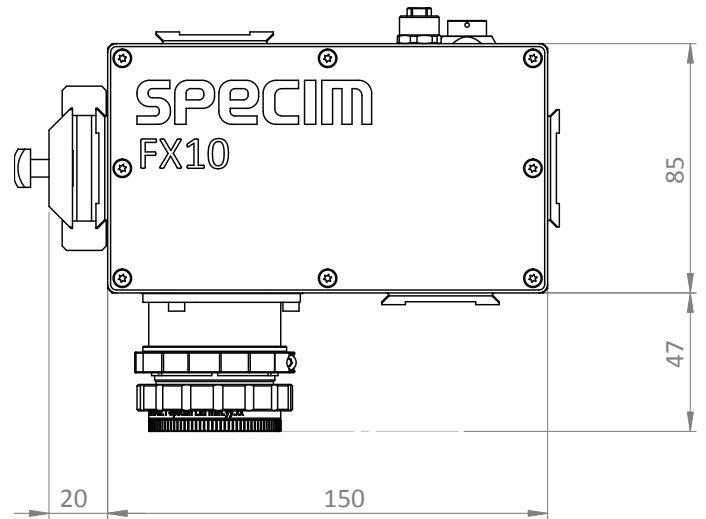

Spectral Range	400-1000 / 400-780 (c-version)	
Spectral resolution (FWHM)	5.5 nm (mean)	
Spectral sampling/pixel	2.7 nm	With default binning
Spectral bands	224 / 70 (c-version)	With default binning
Numerical aperture	1.7	With default lens
Optics magnification	0.80	
Effective pixel size	19.9x9.97 μ m	At fore lens image plane
Effective slit width	42 μ m	At fore lens image plane
Effective slit length	10.2 mm	At fore lens image plane
SNR @ max. signal	420 : 1	
Spatial samples	1024	
Bit depth	12	
Maximum frame rate	327 FPS full range / 514 FPS full range (c-version)	
Binning	2,4,8 spectral and spatial	Default: 2 spectral x 1 spatial
ROI	Freely selectable multiple bands of interest	Minimum height of ROI is two 1-binned rows. Maximum frame rate is determined by the total number of rows included in the mMROI's
Pixel operability	99.993%	
Image corrections	Non uniformity correction Bad pixel replacement Automatic Image Enhancement (AIE)	One point NUC AIE: Unified spectral calibration + corrected smile and keystone aberrations
Sensor material	CMOS	
Sensor cooling	Passive	
Full well capacity	90 ke-	
Read-out modes	IWR / ITR	
Optics temperature	Passive	
Lens mount	Custom mount	
Fore lens FOV options	12 deg 38 deg (default) 47 deg 51 deg 83 deg	Only the default lens is specifically designed for FX10. With other lens options, optical parameters may vary.
Camera digital data output/control interface	GigE Vision, CameraLink	
Camera control protocols	GenICam, ASCII	
Power input	12 V DC (+-10%)	
Power consumption	Max 4 W	
Connectors	Industrial Ethernet OR CameraLink 26-pin, 0.5" MDR	
IP	IP52	
Dimensions (L x W x H)	150 x 85 x 71 mm	Mounting surface option on three sides. Mounting kit adds 24 mm distance on mounting side.
Weight	1.3 kg	
Storage temperature	-20 ... +50°C (non-condensing)	
Operating temperature	+5 ... +40°C (non-condensing)	
Relative humidity	5% – 95% (non-condensing)	